

XLT[®]

SmartSolutions™

1620

Countertop Oven

16" WIDE CONVEYOR

20" LONG BAKE CHAMBER

ELECTRIC

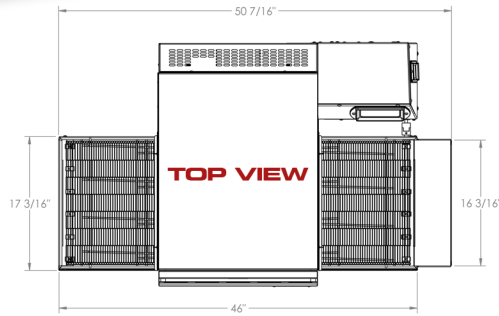

FRONT VIEWS

SIDE VIEWS

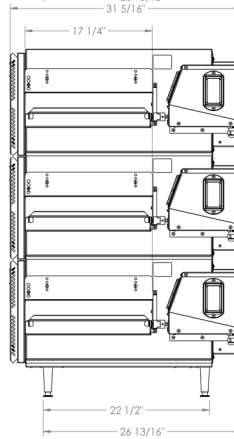
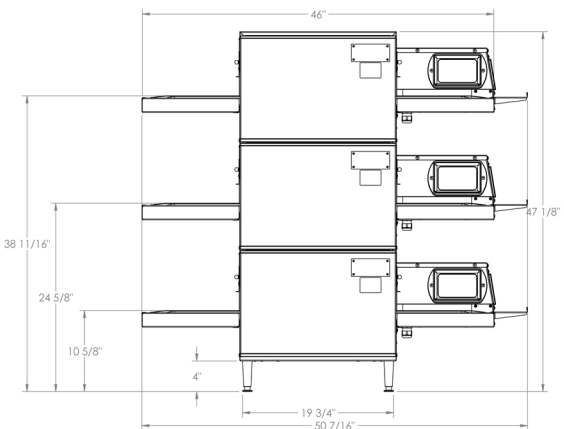
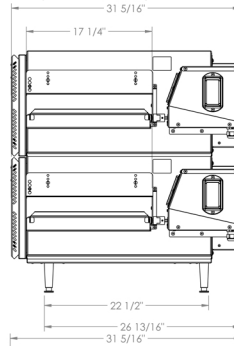
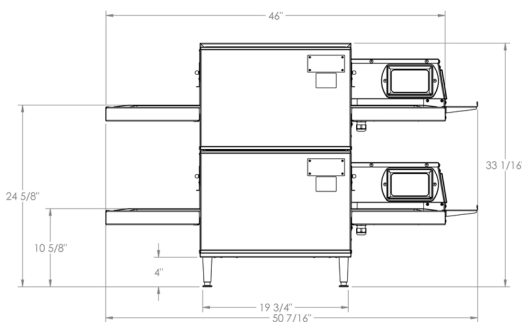
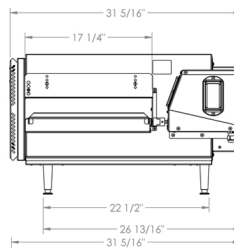
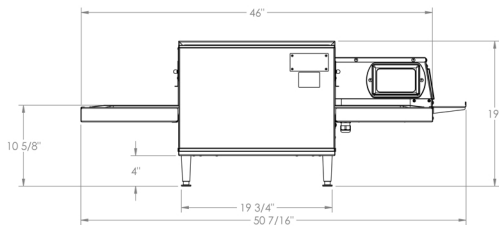

SPECIFICATIONS

ELECTRICAL REQUIREMENT (PER OVEN)

STANDARD

208 Volt
1 Phase
60 Hz
30 Amp

WORLD - Option 1

240 Volt
1 Phase
50 Hz
30 Amp

WORLD - Option 2

380 Volt
3 Phase
50 Hz
15 Amp

WEIGHT (APPROX.)

Single: 188 lbs / 85.3 kg
Double: 360 lbs / 163.3 kg
Triple: 530 lbs / 240.4 kg

WARRANTY

USA & CANADA
2 YEARS

INTERNATIONAL
2 YEARS

WWW.XLTOVENS.COM

24/7/365 LIVE TECHNICAL SUPPORT

service@xltovens.com

(316) 943-2751

sales@xltovens.com